

# TEST REPORT

## CERTIFICATE OF CONFORMITY

**Standard:** 47 CFR FCC Part 15, Subpart B, Class A  
ANSI C63.4: 2014

**Report No.:** FDBDBO-WTW-P23040108

**Product:** Edge AI Computing System

**Brand:** Vecow

**Model No.:** EIC-2000

**Series Model:** EIC-2000 Series, EIC-2XXXXXXXXXXXXXXXXX ("X" can be 0-9, A-Z, or blank for marketing purpose)

**Received Date:** 2023/4/7

**Test Date:** 2023/4/7 ~ 2023/4/11

**Issued Date:** 2023/5/12

**Applicant:** Vecow Co., Ltd.

**Address:** 3F., No. 10, Jiankang Rd., Zhonghe Dist., New Taipei City 23586, Taiwan

**Issued By:** Bureau Veritas Consumer Products Services (H.K.) Ltd., Taoyuan Branch  
Lin Kou Laboratories

**Lab Address:** No. 47-2, 14th Ling, Chia Pau Vil., Lin Kou Dist., New Taipei City, Taiwan

**Test Location:** No. 47-2, 14th Ling, Chia Pau Vil., Lin Kou Dist., New Taipei City, Taiwan

### FCC Registration /

**Designation Number:** 418586 / TW1078

**Approved by:** Jim Hsiang, **Date:** 2023/5/12  
Jim Hsiang / Associate Technical Manager

This test report consists of 28 pages in total. It may be duplicated completely for legal use with the approval of the applicant. It should not be reproduced except in full, without the written approval of our laboratory. The test results in the report only apply to the tested sample. The test results in this report are traceable to the national or international standards.



Prepared by : Albee Chu / Senior Specialist

This report is governed by, and incorporates by reference, the Conditions of Testing as posted at the date of issuance of this report at <http://www.bureauveritas.com/home/about-us/our-business/cps/about-us/terms-conditions/>, and is intended for your exclusive use. Any copying or replication of this report to or for any other person or entity, or use of our name or trademark, is permitted only with our prior written permission. This report sets forth our findings solely with respect to the test samples identified herein. The results set forth in this report are not indicative or representative of the quality or characteristics of the lot from which a test sample was taken or any similar or identical product unless specifically and expressly noted. Our report includes all of the tests requested by you and the results thereof based upon the information that you provided to us. Measurement uncertainty is only provided upon request for accredited tests. Statements of conformity are based on simple acceptance criteria without taking measurement uncertainty into account, unless otherwise requested in writing. You have 60 days from date of issuance of this report to notify us of any material error or omission caused by our negligence or if you require measurement uncertainty; provided, however, that such notice shall be in writing and shall specifically address the issue you wish to raise. A failure to raise such issue within the prescribed time shall constitute your unqualified acceptance of the completeness of this report, the tests conducted and the correctness of the report contents.

## Table of Contents

<b>Release Control Record .....</b>	<b>3</b>
<b>1 Certificate.....</b>	<b>4</b>
<b>2 Summary of Test Results .....</b>	<b>5</b>
2.1 Measurement Uncertainty .....	5
2.2 Supplementary Information .....	5
<b>3 General Information .....</b>	<b>6</b>
3.1 Description of EUT .....	6
3.2 Primary Clock Frequencies of Internal Source.....	6
3.3 Features of EUT .....	6
3.4 Operating Modes of EUT and Determination of Worst Case Operating Mode .....	7
3.5 Test Program Used and Operation Descriptions .....	8
3.6 Connection Diagram of EUT and Peripheral Devices .....	8
3.7 Configuration of Peripheral Devices and Cable Connections .....	9
<b>4 Test Instruments .....</b>	<b>10</b>
4.1 Conducted Emissions from Power Ports.....	10
4.2 Radiated Emissions up to 1 GHz .....	11
4.3 Radiated Emissions above 1 GHz.....	12
<b>5 Limits of Test Items.....</b>	<b>13</b>
5.1 Conducted Emissions from Power Ports.....	13
5.2 Radiated Emissions up to 1 GHz .....	13
5.3 Radiated Emissions above 1 GHz.....	13
<b>6 Test Arrangements.....</b>	<b>14</b>
6.1 Conducted Emissions from Power Ports.....	14
6.2 Radiated Emissions up to 1 GHz .....	15
6.3 Radiated Emissions above 1 GHz.....	16
<b>7 Test Results of Test Item .....</b>	<b>17</b>
7.1 Conducted Emissions from Power Ports.....	17
7.2 Radiated Emissions up to 1 GHz .....	21
7.3 Radiated Emissions above 1 GHz.....	23
<b>8 Pictures of Test Arrangements .....</b>	<b>25</b>
8.1 Conducted Emissions from Power Ports.....	25
8.2 Radiated Emissions up to 1 GHz .....	26
8.3 Radiated Emissions above 1 GHz.....	27
<b>9 Information of the Testing Laboratories .....</b>	<b>28</b>



## Release Control Record

Issue No.	Description	Date Issued
FDBDBO-WTW-P23040108	Original release.	2023/5/12

## 1 Certificate

**Product:** Edge AI Computing System

**Brand:** Vecow

**Test Model:** EIC-2000

**Series Model:** EIC-2000 Series, EIC-2XXXXXXXXXXXXXXXXX ("X" can be 0-9, A-Z, or blank for marketing purpose)

**Sample Status:** Engineering sample

**Applicant:** Vecow Co., Ltd.

**Test Date:** 2023/4/7 ~ 2023/4/11

**Standard:** 47 CFR FCC Part 15, Subpart B, Class A  
ANSI C63.4: 2014

The above equipment has been tested by **Bureau Veritas Consumer Products Services (H.K.) Ltd., Taoyuan Branch**, and found compliance with the requirement of the above standards. The test record, data evaluation & Equipment Under Test (EUT) configurations represented herein are true and accurate accounts of the measurements of the sample's EMC characteristics under the conditions specified in this report.

## 2 Summary of Test Results

The test items that the EUT need to perform in accordance with its interfaces, evaluated functions, are as follows:

Standard / Clause	Test Item	Result	Remark
FCC Part 15.107	Conducted Emissions from Power Ports	Pass	Minimum passing Class A margin is -26.06 dB at 0.65399 MHz
FCC Part 15.109	Radiated Emissions up to 1 GHz	Pass	Minimum passing Class A margin is -0.12 dB at 891.03 MHz
FCC Part 15.109	Radiated Emissions above 1 GHz	Pass	Minimum passing Class A margin is -10.80 dB at 1188.05 MHz

Note: Determining compliance based on the results of the compliance measurement, not taking into account measurement instrumentation uncertainty.

### 2.1 Measurement Uncertainty

Where relevant, the following measurement uncertainty levels have been estimated for tests performed on the EUT as specified in CISPR 16-4-2:

Measurement	Specification	Expanded Uncertainty (k=2) (±)	Maximum allowable uncertainty (±)
Conducted Emissions from Power Ports	150 kHz ~ 30 MHz	2.94 dB	3.4 dB ( $U_{\text{CISPR}}$ )
Radiated Emissions up to 1 GHz	30 MHz ~ 1 GHz	3m : 5.72 dB 10m : 4.38 dB	6.3 dB ( $U_{\text{CISPR}}$ )
	1 GHz ~ 6 GHz	4.94 dB	5.2 dB ( $U_{\text{CISPR}}$ )
Radiated Emissions above 1 GHz	6 GHz ~ 18 GHz	4.60 dB	5.5 dB ( $U_{\text{CISPR}}$ )

The other instruments specified are routine verified to remain within the calibrated levels, no measurement uncertainty is required to be calculated.

### 2.2 Supplementary Information

There is not any deviation from the test standards for the test method, and no modifications required for compliance.

### 3 General Information

#### 3.1 Description of EUT

Product	Edge AI Computing System
Brand	Vecow
Test Model	EIC-2000
Series Model	EIC-2000 Series, EIC-2XXXXXXXXXXXXXXXXX ("X" can be 0-9, A-Z, or blank for marketing purpose)
Sample Status	Engineering sample
Operating Software	Ubuntu 20.04 LTS
Power Supply Rating	DC from Adapter
Accessory Device	Adapter
Data Cable Supplied	N/A

Note:

The EUT uses following accessory.

Brand	Model	Specification
LITEON	PA-1121-24	AC Input : 100-240V, 2.0A, 50-60Hz DC Output : 24V, 50A, 120W DC Output Cable: 1.5m with one ferrite core

#### 3.2 Primary Clock Frequencies of Internal Source

The highest frequency generated or used within the EUT or on which the EUT operates or tunes is 1.8GHz, provided by Vecow Co., Ltd., for detailed internal source, please refer to the manufacturer's specifications.

#### 3.3 Features of EUT

The tests reported herein were performed according to the method specified by Vecow Co., Ltd., for detailed feature description, please refer to the manufacturer's specifications or user's manual.

Please refer to appendix of the report if the applicant has provided additional descriptions of the EUT.

The EUT configured with the following key components:

Component	Specification
CPU	NXP i.MX 8M Plus Quad Core Arm Cortex-A53 processor 1.8GHz
RAM	On-board 4GB LPDDR4 SDRAM
Storage	On-board 32GB eMMC

### 3.4 Operating Modes of EUT and Determination of Worst Case Operating Mode

The EUT has been pre-tested under following test modes.

Test Condition	
Mode	Radiated Emissions up to 1 GHz
1	Full system
Note: There are both AC 230V/50Hz and AC 120V/60Hz to be pre-tested then 120V/60Hz has the highest emission value.	

Test modes are presented in the report as below.

Test Condition	
Mode	Conducted Emissions from Power Ports
A	Full system + Input Power(120 Vac, 60 Hz)
B	Full system + Input Power(240 Vac, 60 Hz)
Mode	Radiated Emissions up to 1 GHz
A	Full system + Input Power(120 Vac, 60 Hz)
Mode	Radiated Emissions above 1 GHz
A	Full system + Input Power(120 Vac, 60 Hz)

### 3.5 Test Program Used and Operation Descriptions

- a. Turned on the power of all equipment.
- b. EUT ran a test program to enable all functions.
- c. EUT read and wrote messages to/ from Micro SD card.
- d. Laptop (kept in a remote area) sent and received messages to/ from EUT the via STP cable.
- e. EUT sent "H" messages to monitor. Then it displayed messages on its screen.
- f. EUT sent "1kHz audio" signal to earphone.
- g. Steps c-f were repeated.

### 3.6 Connection Diagram of EUT and Peripheral Devices

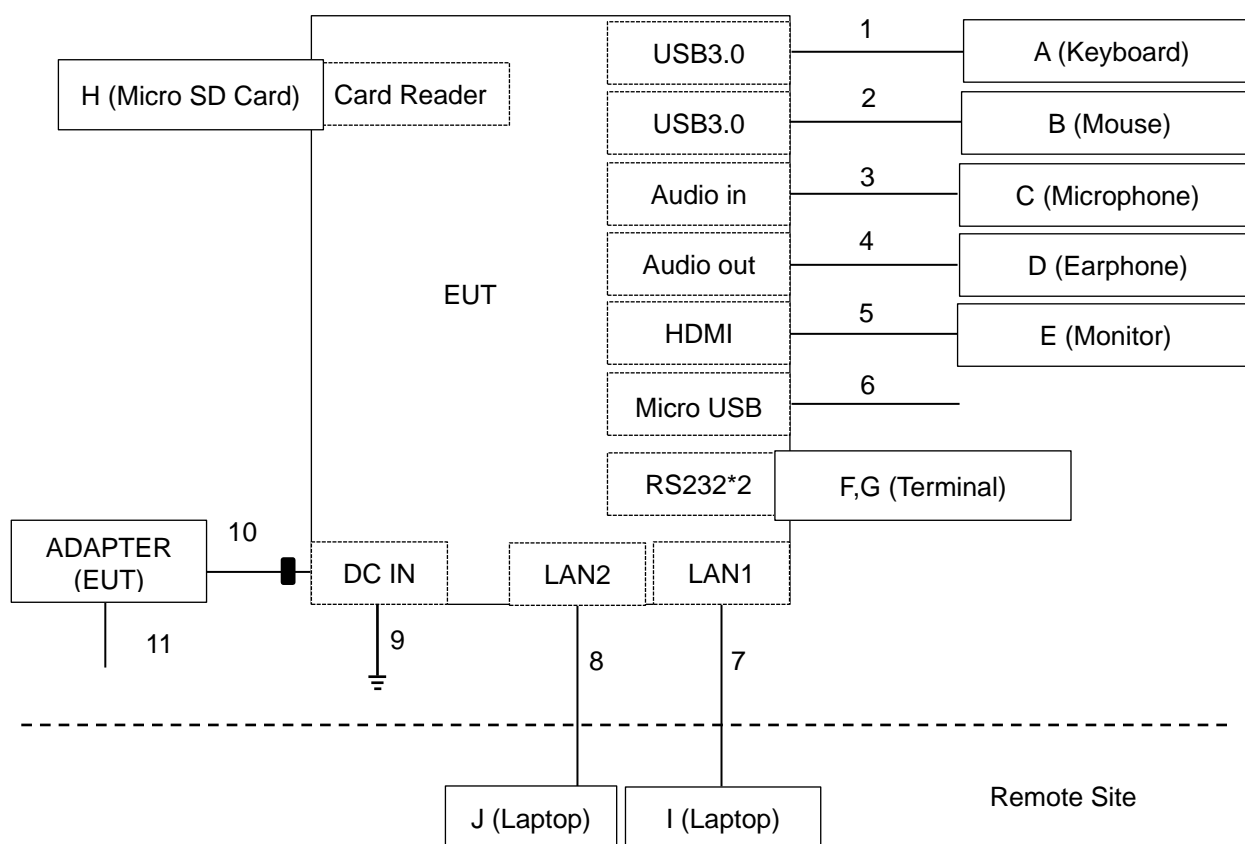



### 3.7 Configuration of Peripheral Devices and Cable Connections

ID	Product	Brand	Model No.	Serial No.	FCC ID	Remarks
A	USB Keyboard	Dell	KB216t	CN-0W33XP-LO300-7CL-191E	N/A	Provided by Lab
B	USB Mouse	DELL	MOCZUL	CN-049TWY-PRC00-77B-0083	N/A	Provided by Lab
C	Microphone	E-books	E-EPB099	N/A	N/A	Provided by Lab
D	Earphone	PHILIPS	SBC HL145	N/A	N/A	Provided by Lab
E	Monitor	ASUS	PA279CV	M7LMTF235958	DoC	Provided by Lab
F	Terminal	N/A	N/A	N/A	N/A	Supplied by applicant
G	Terminal	N/A	N/A	N/A	N/A	Supplied by applicant
H	MICRO SD CARD	Transcend	N/A	N/A	N/A	Supplied by applicant
I	Laptop	LENOVO	T480	PF1EZSA2	N/A	Provided by Lab
J	Laptop	LENOVO	T480	PF1EK03U	N/A	Provided by Lab

ID	Cable Descriptions	Qty.	Length (m)	Shielding (Yes/No)	Cores (Qty.)	Remarks
1	USB cable	1	1.8	Yes	0	Provided by Lab
2	USB cable	1	1.8	Yes	0	Provided by Lab
3	Audio cable	1	2	No	0	Provided by Lab
4	Audio cable	1	1.5	No	0	Provided by Lab
5	HDMI cable	1	2	Yes	0	Provided by Lab, HDMI 2.0 (Brand: Amber, Model: HDMI-AA120)
6	USB (Micro) cable	1	1.2	Yes	0	Provided by Lab
7	RJ45 (Cat. 5e) cable	1	10	Yes	0	Provided by Lab
8	RJ45 (Cat. 5e) cable	1	10	Yes	0	Provided by Lab
9	GND (PE) cable	1	2	No	0	Provided by Lab
10	DC power cable	1	1.5	No	1	Supplied by applicant
11	AC power cable	1	1.8	No	0	Provided by Lab

## 4 Test Instruments

The calibration interval of the all test instruments are 12 months and the calibrations are traceable to NML/ROC and NIST/USA.

### 4.1 Conducted Emissions from Power Ports

Description Manufacturer	Model No.	Serial No.	Calibrated Date	Calibrated Until
50 ohm terminal LYNICS	0900510	E1-011285	2022/9/19	2023/9/18
		E1-011286	2022/9/19	2023/9/18
		E1-011484	2022/6/26	2023/6/25
Attenuator STI	STI02-2200-10	NO.1	2022/9/14	2023/9/13
DC LISN R&S	ESH3-Z6	100219	2022/8/2	2023/8/1
		844950/018	2022/8/2	2023/8/1
DC LISN Schwarzbeck	NNLK 8121	8121-808	2022/4/29	2023/4/28
Isolation Transformer Erika Fiedler	D-65396	017	2022/9/8	2023/9/7
LISN R&S	ENV216	101195	2022/8/1	2023/7/31
		101197	2022/7/5	2023/7/4
	ESH3-Z5	100220	2022/11/24	2023/11/23
LISN Schwarzbeck	NNLK 8121	8121-731	2022/5/26	2023/5/25
	NNLK8129	8129229	2022/6/8	2023/6/7
Receiver R&S	ESCI	100412	2022/8/22	2023/8/21
RF Coaxial Cable Commate	5D-FB	Cable-CO10-01	2023/2/8	2024/2/7
Software BVADT	Cond_V7.3.7.4	N/A	N/A	N/A

Notes:

1. The test was performed in Linkou Conduction 10.
2. The VCCI Site Registration No. C-11852.
3. Tested Date: 2023/4/11

## 4.2 Radiated Emissions up to 1 GHz

Description Manufacturer	Model No.	Serial No.	Calibrated Date	Calibrated Until
ADT. Tower	AT100	0205	N/A	N/A
ADT. Turn Table	TT100	0205	N/A	N/A
Attenuator Mini-Circuits	UNAT-5+	PAD-ST2-01	2022/10/21	2023/10/20
Bi-log Broadband Antenna Schwarzbeck	VULB9168	9168-303	2022/10/25	2023/10/24
Coupling/Dcoupling Network Schwarzbeck	CDNE-M2	00097	2022/6/1	2023/5/31
	CDNE-M3	00091	2022/6/1	2023/5/31
Preamplifier Agilent	8447D	2944A11062	2023/2/15	2024/2/14
Pre_Amplifier EMCI	EMC9135	980711	2023/3/12	2024/3/11
Pre_Amplifier HP	8447D	2944A08313	2023/2/15	2024/2/14
RF Coaxial Cable Pacific	8D-FB	Cable-ST2-01	2022/10/21	2023/10/20
Software BVADT	Radiated_V7.6.15.9.5	N/A	N/A	N/A
TEST RECEIVER R&S	ESCS 30	100276	2022/4/19	2023/4/18
		100292	2022/8/30	2023/8/29

### Notes:

1. The test was performed in Linkou Open Site2 , The test site validated date: 2022/7/16 (NSA)
2. The VCCI Site Registration No. R-10237.
3. Tested Date: 2023/4/7

### 4.3 Radiated Emissions above 1 GHz

Description Manufacturer	Model No.	Serial No.	Calibrated Date	Calibrated Until
Attenuator Mini-Circuits	BW-K3-2W44+	PAD-CH7-03	2022/7/7	2023/7/6
	BW-N4W5+	PAD-CH7-02	2022/7/7	2023/7/6
Band Pass Filter MICRO-TRONICS	BRM17690	005	2022/5/26	2023/5/25
Fix tool for Boresight antenna tower BV	BAF-01	4	N/A	N/A
Horn Antenna EMCO	3115	9312-4192	2022/11/13	2023/11/12
Horn Antenna ETS-Lindgren	3117-PA	00215857	2023/2/3	2024/2/2
Horn Antenna Schwarzbeck	BBHA-9170	BBHA9170190	2022/11/13	2023/11/12
Notch Filter MICRO-TRONICS	BRC50703-01	010	2022/5/26	2023/5/25
Pre-amplifier HP	8449B	3008A01292	2023/2/16	2024/2/15
Pre-amplifier (18GHz-40GHz) EMCI	EMC184045B	980175	2022/9/3	2023/9/2
Pre_Amplifier EMCI	EMC0126545	980076	2023/2/16	2024/2/15
	EMC184045B	980235	2023/2/16	2024/2/15
RF Coaxial Cable HUBER SUHNER	SF-102	Cable-CH7(3.6M)-02	2022/7/7	2023/7/6
Software BVADT	Radiated_V8.7.08	N/A	N/A	N/A
Spectrum Keysight	N9020B	MY60110438	2022/12/6	2023/12/5
		MY60112260	2022/5/21	2023/5/20
Test Receiver Agilent	N9038A	MY50010135	2022/8/30	2023/8/29
		MY51210114	2023/1/3	2024/1/2
Turn Table & Tower Max Full	MF7802	MF780208103	N/A	N/A

Notes:

1. The test was performed in Linkou 966 Chamber 2 (CH 7).
2. The VCCI Site Registration No. G-10039.
3. Tested Date: 2023/4/11

## 5 Limits of Test Items

### 5.1 Conducted Emissions from Power Ports

Frequency (MHz)	Class A (dBuV)		Class B (dBuV)	
	Quasi-peak	Average	Quasi-peak	Average
0.15 - 0.5	79	66	66 - 56	56 - 46
0.50 - 5.0	73	60	56	46
5.0 - 30.0	73	60	60	50

Notes: 1. The lower limit shall apply at the transition frequencies.  
 2. The limit decreases linearly with the logarithm of the frequency in the range of 0.15 to 0.50 MHz.

### 5.2 Radiated Emissions up to 1 GHz

Emissions radiated outside of the specified bands, shall be according to the general radiated limits as following:

Radiated Emissions Limits at 10 meters (dB $\mu$ V/m)				
Frequencies (MHz)	FCC 15B, Class A	FCC 15B, Class B	CISPR 22, Class A	CISPR 22, Class B
30-88	39.1	29.5	40	30
88-216	43.5	33.1		
216-230	46.4	35.6		
230-960				
960-1000	49.5	43.5	47	37

Radiated Emissions Limits at 3 meters (dB $\mu$ V/m)				
Frequencies (MHz)	FCC 15B, Class A	FCC 15B, Class B	CISPR 22, Class A	CISPR 22, Class B
30-88	49.5	40.0	50.5	40.5
88-216	54.0	43.5		
216-230	56.9	46.0		
230-960				
960-1000	60.0	54.0	57.5	47.5

Notes: 1. The lower limit shall apply at the transition frequencies.

### 5.3 Radiated Emissions above 1 GHz

Frequency Range (For unintentional radiators)

Highest frequency generated or used in the device or on which the device operates or tunes (MHz)	Upper frequency of measurement range (MHz)
Below 1.705	30
1.705-108	1000
108-500	2000
500-1000	5000
Above 1000	5th harmonic of the highest frequency or 40GHz, whichever is lower

Radiated Emissions Limits at 3 meters (dB $\mu$ V/m)		
Frequency range	Class A	Class B
Above 1GHz	Avg: 60 Peak: 80	Avg: 54 Peak: 74

Notes: 1. These limit levels apply for a measurement distance of 3 m. If using a different measurement distance, the measured levels shall be extrapolated to the 3 m limit distance using a factor of 20 dB per decade of distance. The measurement distance shall place the measurement antenna in the far field of the ITE or digital apparatus under test.

## 6 Test Arrangements

### 6.1 Conducted Emissions from Power Ports

- For the table-top EUT is placed on a 0.8 meter insulation table; for the floor standing EUT shall be insulated (by insulation of 12 mm) from the horizontal reference ground plane. The EUT is placed 0.4 meters from the conducting wall of the shielded room with EUT being connected to the power mains through a line impedance stabilization network (LISN). Other support units are connected to the power mains through another LISN. They provide coupling impedance for the measuring instrument.
- Both lines of the power mains connected to the EUT were checked for maximum conducted interference.
- The test results of conducted emissions at mains ports are recorded of six worst margins for quasi-peak (mandatory) [and average (if necessary)] values against the limits at frequencies of interest unless the margin is 20 dB or greater.

Note: The resolution bandwidth and video bandwidth of test receiver is 9kHz for quasi-peak detection (QP) and average detection (AV) at frequency 0.15MHz-30MHz.

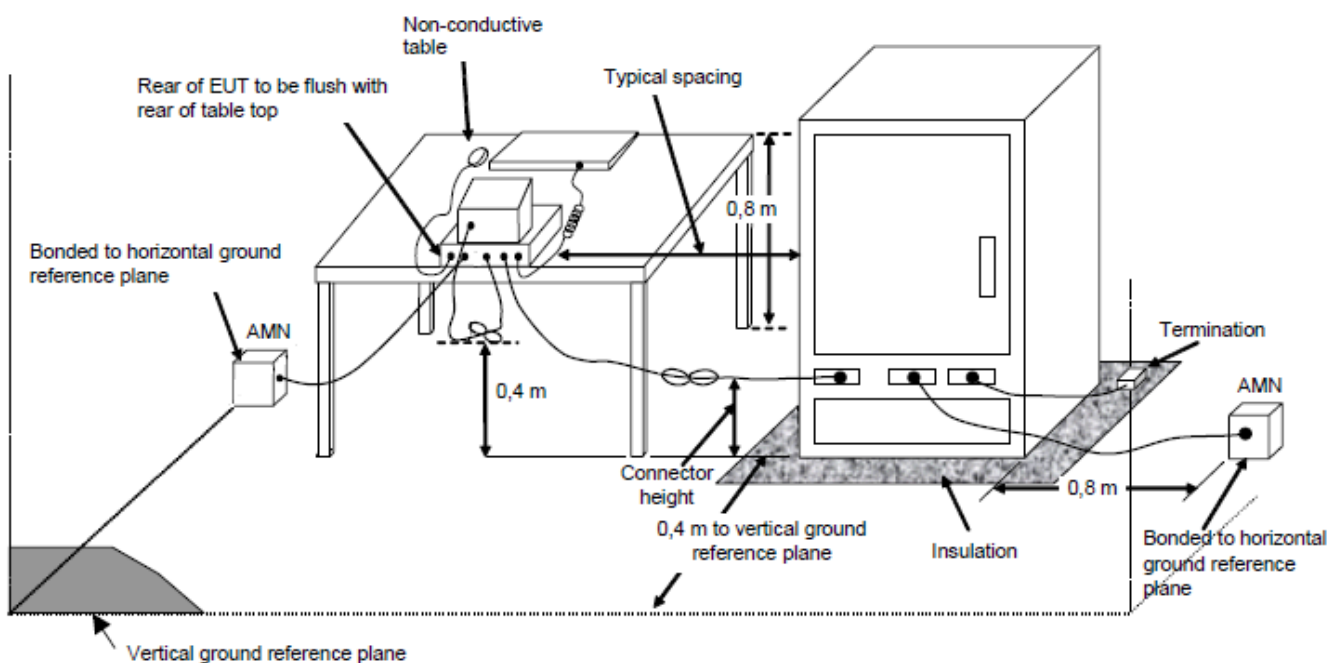

For the actual test configuration, please refer to the related Item – Photographs of the Test Configuration.

## 6.2 Radiated Emissions up to 1 GHz

- a. For the table-top EUT is placed on a 0.8 meter to the top of rotating table; for the floor standing EUT shall be insulated (by insulation of 12 mm) from the horizontal reference ground plane. The rotating table is rotated 360 degrees to determine the position of the highest radiation. If the equipment requires a dedicated ground connection, this shall be provided and bonded to the RGP.
- b. The EUT was set 10 meters away from the interference-receiving antenna, which was mounted on the top of a variable-height antenna tower.
- c. The antenna is a broadband antenna, and its height is varied from one meter to four meters above the ground to determine the maximum value of the field strength. Both horizontal and vertical polarizations of the antenna are set to make the measurement.
- d. For each suspected emission, the EUT was arranged to its worst case and then the antenna was tuned to heights from 1 meter to 4 meters and the rotatable table was turned from 0 degrees to 360 degrees to find the maximum reading.
- e. The test-receiver system was set to quasi-peak detect function and specified bandwidth with maximum hold mode when the test frequency is up to 1 GHz.

Note: The resolution bandwidth and video bandwidth of test receiver/spectrum analyzer is 120kHz for quasi-peak detection (QP) at frequency up to 1GHz.

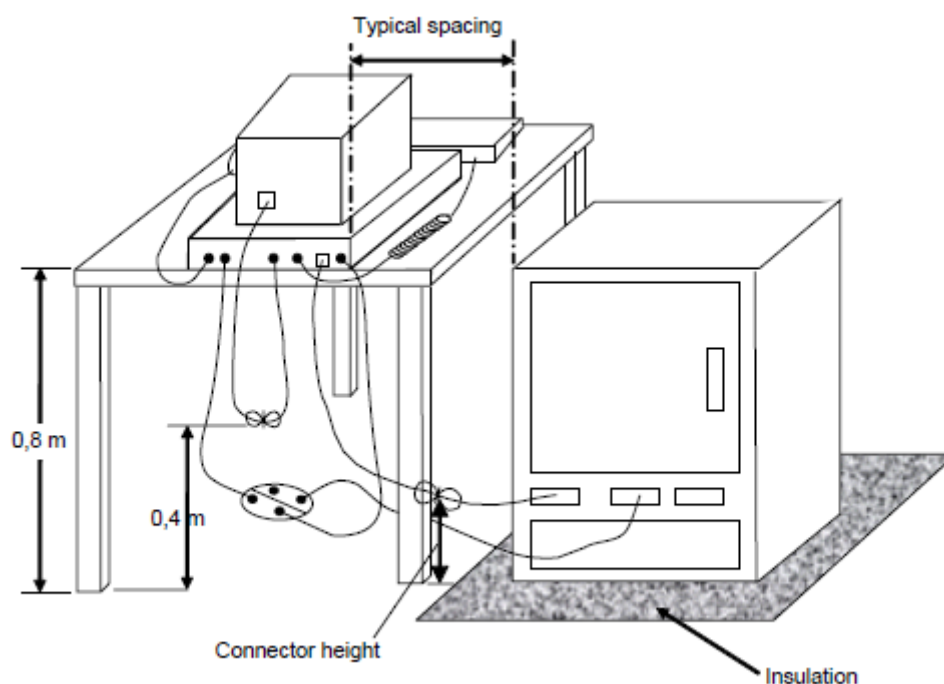

For the actual test configuration, please refer to the related Item – Photographs of the Test Configuration.

### 6.3 Radiated Emissions above 1 GHz

- For the table-top EUT is placed on a 0.8 meter to the top of rotating table; for the floor standing EUT shall be insulated (by insulation of 12 mm) from the horizontal reference ground plane. The rotating table is rotated 360 degrees to determine the position of the highest radiation. If the equipment requires a dedicated ground connection, this shall be provided and bonded to the RGP.
- The EUT was set  $d = 3$  meters away from the interference-receiving antenna, which was mounted on the top of a variable-height antenna tower.
- The height of antenna can be varied from one meter to four meters, the height of adjustment depends on the EUT height and the antenna 3dB beamwidth both, to detect the maximum value of the field strength. Both horizontal and vertical polarizations of the antenna are set to make the measurement.
- For each suspected emission, the EUT was arranged to its worst case and then the antenna was tuned to heights and the rotatable table was turned from 0 degrees to 360 degrees to find the maximum reading.
- The spectrum analyzer system was set to peak and average detects function and specified bandwidth with maximum hold mode when the test frequency is above 1 GHz.

Note: The resolution bandwidth of test receiver/spectrum analyzer is 1MHz and video bandwidth is 3MHz for Peak detection (PK) at frequency above 1GHz. The resolution bandwidth of test receiver/spectrum analyzer is 1 MHz for Average detection (AV) at frequency above 1GHz.

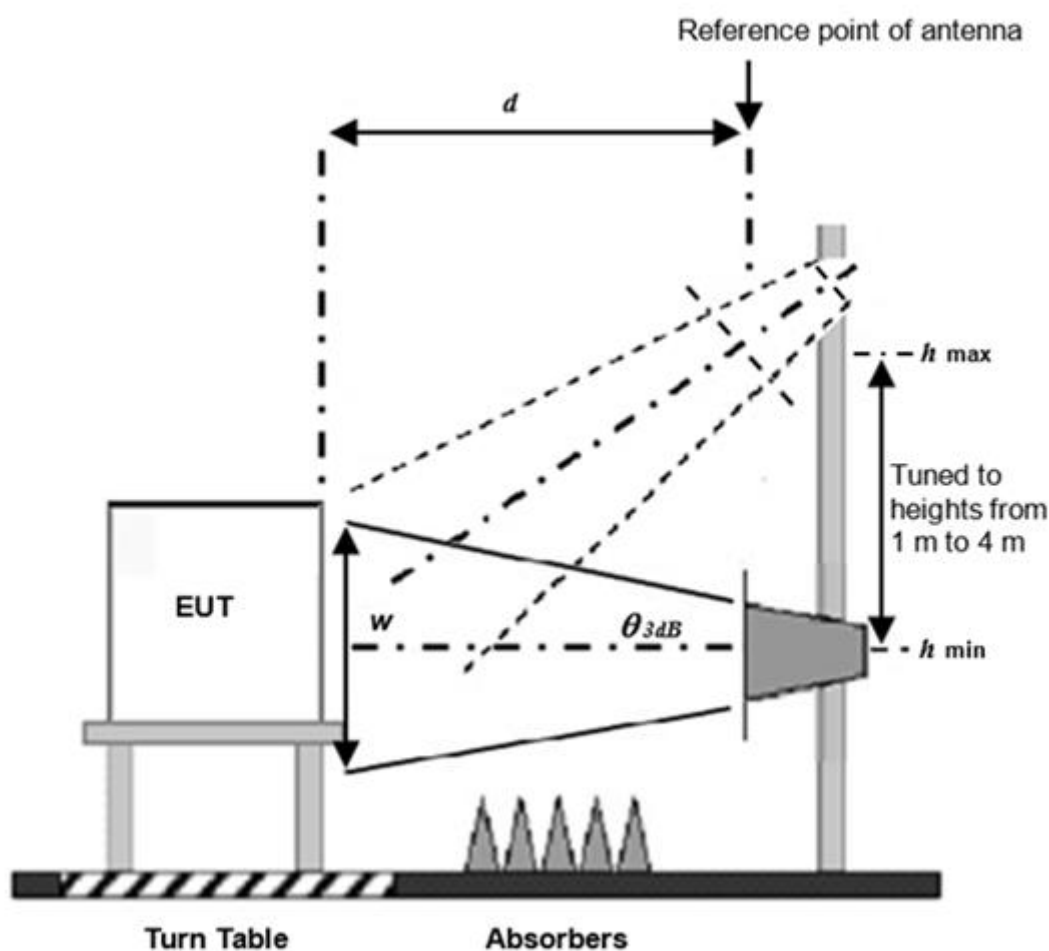

For the actual test configuration, please refer to the related item – Photographs of the Test Configuration.



## 7 Test Results of Test Item

### 7.1 Conducted Emissions from Power Ports

#### Mode A

Frequency Range	150 kHz ~ 30 MHz	Detector Function & Resolution Bandwidth	Quasi-Peak (QP) / Average (AV), 9kHz
Input Power	120 Vac, 60 Hz	Environmental Conditions	22°C, 69% RH
Tested by	John Liao		

Phase Of Power : Line (L)										
No	Frequency (MHz)	Correction Factor (dB)	Reading Value (dBuV)		Emission Level (dBuV)		Limit (dBuV)		Margin (dB)	
			Q.P.	AV.	Q.P.	AV.	Q.P.	AV.	Q.P.	AV.
1	0.15001	9.73	17.33	12.99	27.06	22.72	79.00	66.00	-51.94	-43.28
2	0.45859	9.73	32.25	23.12	41.98	32.85	79.00	66.00	-37.02	-33.15
<b>3</b>	<b>0.65399</b>	<b>9.74</b>	<b>32.25</b>	<b>24.20</b>	<b>41.99</b>	<b>33.94</b>	<b>73.00</b>	<b>60.00</b>	<b>-31.01</b>	<b>-26.06</b>
4	0.80625	9.74	30.95	21.16	40.69	30.90	73.00	60.00	-32.31	-29.10
5	6.85938	9.88	25.32	21.09	35.20	30.97	73.00	60.00	-37.80	-29.03
6	16.77344	9.93	29.36	23.03	39.29	32.96	73.00	60.00	-33.71	-27.04

#### Remarks:

1. Q.P. and AV. are abbreviations of quasi-peak and average individually.
2. The emission levels of other frequencies were very low against the limit.
3. Margin value = Emission level – Limit value
4. Correction factor = Insertion loss + Cable loss
5. Emission Level = Correction Factor + Reading Value

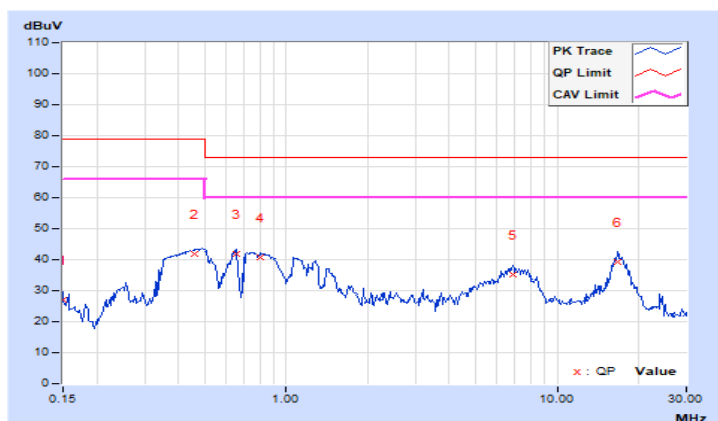

<b>Frequency Range</b>	150 kHz ~ 30 MHz	<b>Detector Function &amp; Resolution Bandwidth</b>	Quasi-Peak (QP) / Average (AV), 9kHz
<b>Input Power</b>	120 Vac, 60 Hz	<b>Environmental Conditions</b>	22°C, 69% RH
<b>Tested by</b>	John Liao		

Phase Of Power : Neutral (N)										
No	Frequency (MHz)	Correction Factor (dB)	Reading Value (dBuV)		Emission Level (dBuV)		Limit (dBuV)		Margin (dB)	
			Q.P.	AV.	Q.P.	AV.	Q.P.	AV.	Q.P.	AV.
1	0.15391	9.68	17.36	13.05	27.04	22.73	79.00	66.00	-51.96	-43.27
2	0.48203	9.68	28.96	22.07	38.64	31.75	79.00	66.00	-40.36	-34.25
3	0.65012	9.68	28.76	19.24	38.44	28.92	73.00	60.00	-34.56	-31.08
4	1.25013	9.71	27.32	18.93	37.03	28.64	73.00	60.00	-35.97	-31.36
5	6.57031	9.84	24.18	19.45	34.02	29.29	73.00	60.00	-38.98	-30.71
6	17.17188	9.95	23.12	17.03	33.07	26.98	73.00	60.00	-39.93	-33.02

**Remarks:**

1. Q.P. and AV. are abbreviations of quasi-peak and average individually.
2. The emission levels of other frequencies were very low against the limit.
3. Margin value = Emission level – Limit value
4. Correction factor = Insertion loss + Cable loss
5. Emission Level = Correction Factor + Reading Value

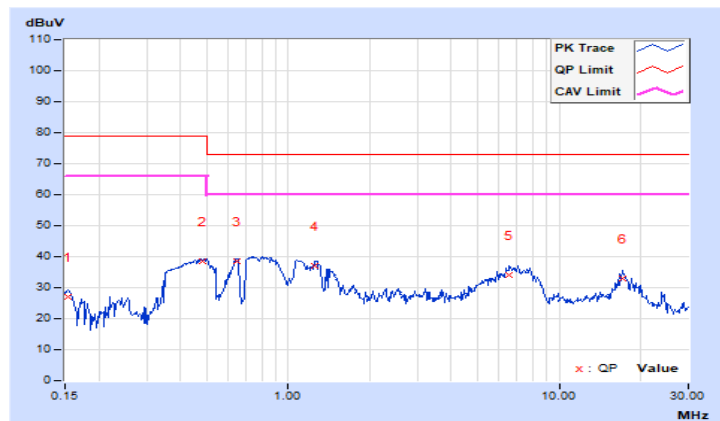

### Mode B

<b>Frequency Range</b>	150 kHz ~ 30 MHz	<b>Detector Function &amp; Resolution Bandwidth</b>	Quasi-Peak (QP) / Average (AV), 9kHz
<b>Input Power</b>	240 Vac, 60 Hz	<b>Environmental Conditions</b>	22°C, 69% RH
<b>Tested by</b>	John Liao		

Phase Of Power : Line (L)										
No	Frequency (MHz)	Correction Factor (dB)	Reading Value (dBuV)		Emission Level (dBuV)		Limit (dBuV)		Margin (dB)	
			Q.P.	AV.	Q.P.	AV.	Q.P.	AV.	Q.P.	AV.
1	0.16562	9.73	25.12	19.65	34.85	29.38	79.00	66.00	-44.15	-36.62
2	0.60703	9.74	35.12	23.48	44.86	33.22	73.00	60.00	-28.14	-26.78
3	0.77109	9.74	29.11	21.07	38.85	30.81	73.00	60.00	-34.15	-29.19
4	1.15616	9.76	28.16	20.45	37.92	30.21	73.00	60.00	-35.08	-29.79
5	9.49609	9.91	24.17	17.06	34.08	26.97	73.00	60.00	-38.92	-33.03
6	16.89453	9.93	25.01	18.99	34.94	28.92	73.00	60.00	-38.06	-31.08

#### Remarks:

1. Q.P. and AV. are abbreviations of quasi-peak and average individually.
2. The emission levels of other frequencies were very low against the limit.
3. Margin value = Emission level – Limit value
4. Correction factor = Insertion loss + Cable loss
5. Emission Level = Correction Factor + Reading Value

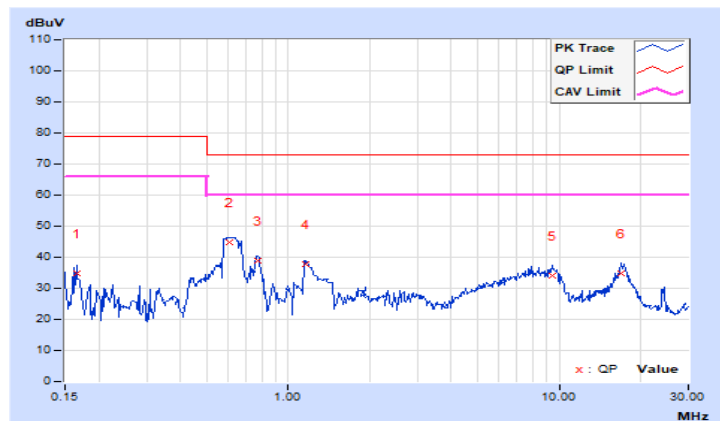

<b>Frequency Range</b>	150 kHz ~ 30 MHz	<b>Detector Function &amp; Resolution Bandwidth</b>	Quasi-Peak (QP) / Average (AV), 9kHz
<b>Input Power</b>	240 Vac, 60 Hz	<b>Environmental Conditions</b>	22°C, 69% RH
<b>Tested by</b>	John Liao		

Phase Of Power : Neutral (N)										
No	Frequency (MHz)	Correction Factor (dB)	Reading Value (dBuV)		Emission Level (dBuV)		Limit (dBuV)		Margin (dB)	
			Q.P.	AV.	Q.P.	AV.	Q.P.	AV.	Q.P.	AV.
1	0.16172	9.68	25.28	17.63	34.96	27.31	79.00	66.00	-44.04	-38.69
2	0.62655	9.68	32.85	22.87	42.53	32.55	73.00	60.00	-30.47	-27.45
3	0.76891	9.69	26.57	18.00	36.26	27.69	73.00	60.00	-36.74	-32.31
4	1.17578	9.70	26.35	19.68	36.05	29.38	73.00	60.00	-36.95	-30.62
5	9.39453	9.88	24.18	20.07	34.06	29.95	73.00	60.00	-38.94	-30.05
6	24.31813	9.97	19.22	18.68	29.19	28.65	73.00	60.00	-43.81	-31.35

**Remarks:**

1. Q.P. and AV. are abbreviations of quasi-peak and average individually.
2. The emission levels of other frequencies were very low against the limit.
3. Margin value = Emission level – Limit value
4. Correction factor = Insertion loss + Cable loss
5. Emission Level = Correction Factor + Reading Value

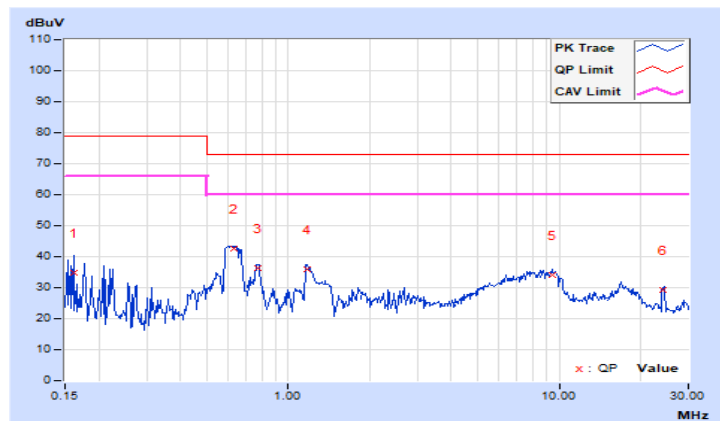

## 7.2 Radiated Emissions up to 1 GHz

### Mode A

Frequency Range	30 MHz ~ 1 GHz	Detector Function & Resolution Bandwidth	Quasi-Peak (QP), 120 kHz
Input Power	120 Vac, 60 Hz	Environmental Conditions	22°C, 75% RH
Tested By	Ed Lin		

Antenna Polarity & Test Distance : Horizontal at 10 m								
No	Frequency (MHz)	Emission Level (dBuV/m)	Limit (dBuV/m)	Margin (dB)	Antenna Height (m)	Table Angle (Degree)	Raw Value (dBuV)	Correction Factor (dB/m)
1	30.70	31.56 QP	40.00	-8.44	4.00 H	301	41.83	-10.27
2	125.00	39.87 QP	40.00	-0.13	4.00 H	84	49.70	-9.83
3	297.15	41.79 QP	47.00	-5.21	3.23 H	0	47.93	-6.14
4	500.52	44.87 QP	47.00	-2.13	1.92 H	107	46.54	-1.67
5	594.25	44.56 QP	47.00	-2.44	1.82 H	193	43.69	0.87
6	625.00	42.31 QP	47.00	-4.69	1.27 H	245	40.51	1.80
7	875.50	43.74 QP	47.00	-3.26	1.00 H	174	36.53	7.21
8	891.04	46.48 QP	47.00	-0.52	1.00 H	172	39.00	7.48
9	999.01	44.52 QP	47.00	-2.48	1.12 H	89	35.08	9.44

#### Remarks:

- Emission Level(dBuV/m) = Raw Value(dBuV) + Correction Factor(dB/m)
- Correction Factor(dB/m) = Antenna Factor (dB/m) + Cable Factor (dB)  
– Pre-Amplifier Factor (dB)
- The other emission levels were very low against the limit.
- Margin value = Emission level – Limit value

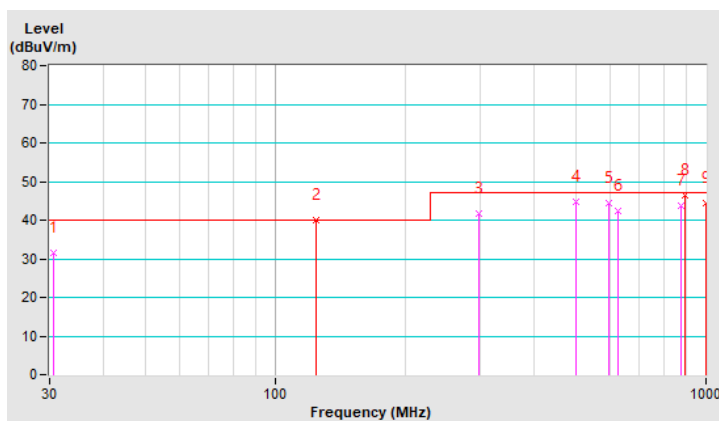

Frequency Range	30 MHz ~ 1 GHz	Detector Function & Resolution Bandwidth	Quasi-Peak (QP), 120 kHz
Input Power	120 Vac, 60 Hz	Environmental Conditions	22°C, 75% RH
Tested By	Ed Lin		

Antenna Polarity & Test Distance : Vertical at 10 m								
No	Frequency (MHz)	Emission Level (dBuV/m)	Limit (dBuV/m)	Margin (dB)	Antenna Height (m)	Table Angle (Degree)	Raw Value (dBuV)	Correction Factor (dB/m)
1	53.63	31.35 QP	40.00	-8.65	1.00 V	94	39.99	-8.64
2	125.08	39.07 QP	40.00	-0.93	1.00 V	76	48.87	-9.80
3	249.97	40.31 QP	47.00	-6.69	1.00 V	0	48.41	-8.10
4	297.15	38.82 QP	47.00	-8.18	1.00 V	0	44.96	-6.14
5	500.01	38.82 QP	47.00	-8.18	2.64 V	20	40.51	-1.69
6	594.25	42.09 QP	47.00	-4.91	3.22 V	0	41.22	0.87
7	875.50	43.44 QP	47.00	-3.56	2.39 V	231	36.23	7.21
<b>8</b>	<b>891.03</b>	<b>46.88 QP</b>	<b>47.00</b>	<b>-0.12</b>	<b>2.33 V</b>	<b>78</b>	<b>39.40</b>	<b>7.48</b>
9	1000.00	42.28 QP	47.00	-4.72	1.62 V	113	32.79	9.49

**Remarks:**

1. Emission Level(dBuV/m) = Raw Value(dBuV) + Correction Factor(dB/m)
2. Correction Factor(dB/m) = Antenna Factor (dB/m) + Cable Factor (dB)  
– Pre-Amplifier Factor (dB)
3. The other emission levels were very low against the limit.
4. Margin value = Emission level – Limit value

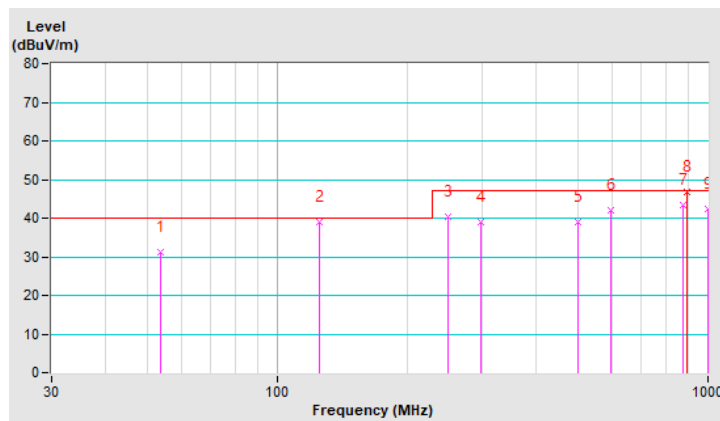

### 7.3 Radiated Emissions above 1 GHz

#### Mode A

Frequency Range	1 GHz ~ 9 GHz	Detector Function & Resolution Bandwidth	Peak (PK) / Average (AV), 1MHz
Input Power	120 Vac, 60 Hz	Environmental Conditions	20°C, 68% RH
Tested By	Desmond Chen		

Antenna Polarity & Test Distance : Horizontal at 3 m								
No	Frequency (MHz)	Emission Level (dBuV/m)	Limit (dBuV/m)	Margin (dB)	Antenna Height (m)	Table Angle (Degree)	Raw Value (dBuV)	Correction Factor (dB/m)
1	1000.41	47.26 PK	80.00	-32.74	2.00 H	5	54.03	-6.77
2	1000.41	29.91 AV	60.00	-30.09	2.00 H	5	36.68	-6.77
3	1188.06	60.39 PK	80.00	-19.61	1.26 H	183	65.49	-5.10
4	1188.06	48.98 AV	60.00	-11.02	1.26 H	183	54.08	-5.10
5	1782.08	50.54 PK	80.00	-29.46	1.00 H	235	53.86	-3.32
6	1782.08	38.59 AV	60.00	-21.41	1.00 H	235	41.91	-3.32

#### Remarks:

1. Emission Level(dBuV/m) = Raw Value(dBuV) + Correction Factor(dB/m)
2. Correction Factor(dB/m) = Antenna Factor (dB/m) + Cable Factor (dB)  
– Pre-Amplifier Factor (dB)
3. The other emission levels were very low against the limit.
4. Margin value = Emission level – Limit value

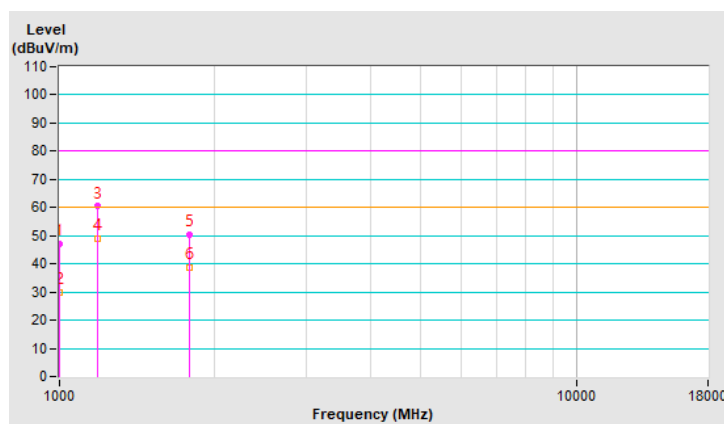

Frequency Range	1 GHz ~ 9 GHz	Detector Function & Resolution Bandwidth	Peak (PK) / Average (AV), 1MHz
Input Power	120 Vac, 60 Hz	Environmental Conditions	20°C, 68% RH
Tested By	Desmond Chen		

Antenna Polarity & Test Distance : Vertical at 3 m								
No	Frequency (MHz)	Emission Level (dBuV/m)	Limit (dBuV/m)	Margin (dB)	Antenna Height (m)	Table Angle (Degree)	Raw Value (dBuV)	Correction Factor (dB/m)
1	1018.32	53.74 PK	80.00	-26.26	1.74 V	174	60.42	-6.68
2	1018.32	31.36 AV	60.00	-28.64	1.74 V	174	38.04	-6.68
3	1188.05	60.04 PK	80.00	-19.96	1.86 V	183	65.14	-5.10
<b>4</b>	<b>1188.05</b>	<b>49.20 AV</b>	<b>60.00</b>	<b>-10.80</b>	<b>1.86 V</b>	<b>183</b>	<b>54.30</b>	<b>-5.10</b>
5	1782.03	51.59 PK	80.00	-28.41	1.92 V	194	54.91	-3.32
6	1782.03	40.05 AV	60.00	-19.95	1.92 V	194	43.37	-3.32

**Remarks:**

1. Emission Level(dBuV/m) = Raw Value(dBuV) + Correction Factor(dB/m)
2. Correction Factor(dB/m) = Antenna Factor (dB/m) + Cable Factor (dB) – Pre-Amplifier Factor (dB)
3. The other emission levels were very low against the limit.
4. Margin value = Emission level – Limit value

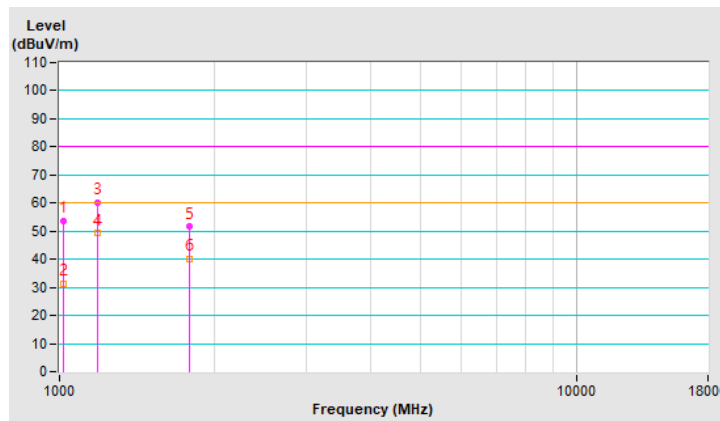



## 8 Pictures of Test Arrangements

### 8.1 Conducted Emissions from Power Ports

#### Mode A and B



## 8.2 Radiated Emissions up to 1 GHz

### Mode A





### 8.3 Radiated Emissions above 1 GHz

#### Mode A

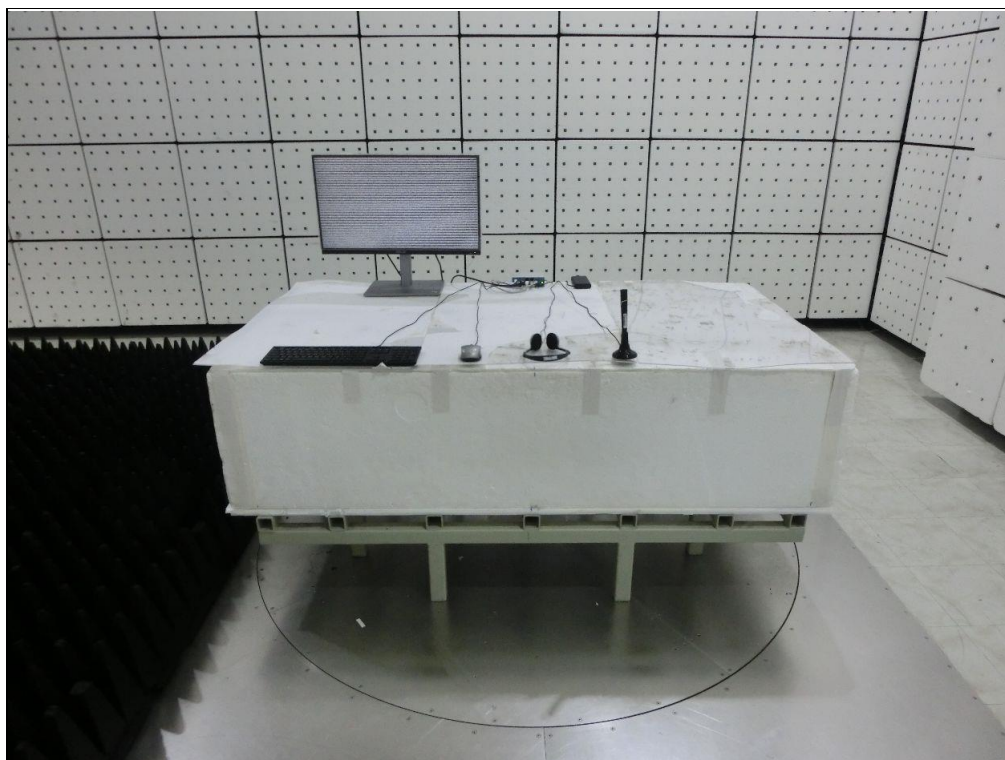

## 9 Information of the Testing Laboratories

We, Bureau Veritas Consumer Products Services (H.K.) Ltd., Taoyuan Branch, were founded in 1988 to provide our best service in EMC, Radio, Telecom and Safety consultation. Our laboratories are FCC recognized accredited test firms and accredited according to ISO/IEC 17025.

If you have any comments, please feel free to contact us at the following:

**Lin Kou EMC/RF Lab**

Tel: 886-2-26052180

Fax: 886-2-26051924

**Hsin Chu EMC/RF/Telecom Lab**

Tel: 886-3-6668565

Fax: 886-3-6668323

**Hwa Ya EMC/RF/Safety Lab**

Tel: 886-3-3183232

Fax: 886-3-3270892

**Email:** [service.adt@bureauveritas.com](mailto:service.adt@bureauveritas.com)

**Web Site:** <http://ee.bureauveritas.com.tw>

The address and road map of all our labs can be found in our web site also.

--- END ---